

11E
4413N

Toyota Hilux, Md. 2021

EU-Personenschutzbügel 60 mit Querrohr 42
EU-Pedestrian Protection Bar 60 mm with cross pipe 42mm
Protection avant, homologuée CEE, 60 mm, traverse 42mm



*Compatible with Automatic Cruise Control /Forward Collision Mitigation
Kompatibel mit Abstandsregeltempomat /Auffahrvermeidungs-oder warnsystem
compatible avec radar de régulation de distance/ freinage autonome d'urgence



ASSEMBLY INSTRUCTION

Montageanleitung • Instructions de montage

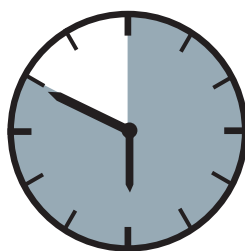

50 Minuten

Artikel-Nr:
11E4413N (S) inox
11E5413N steel black

Revision 1: 09.09.2021



M6:
10 Nm
M8 (A2):
21,4 Nm
M12:
87 Nm

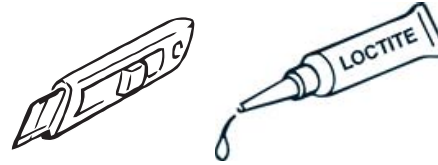
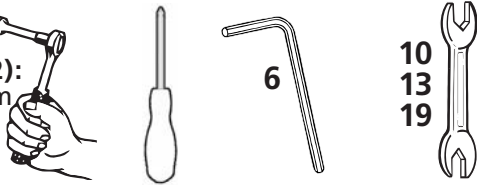

mounting kit: 11E9413N

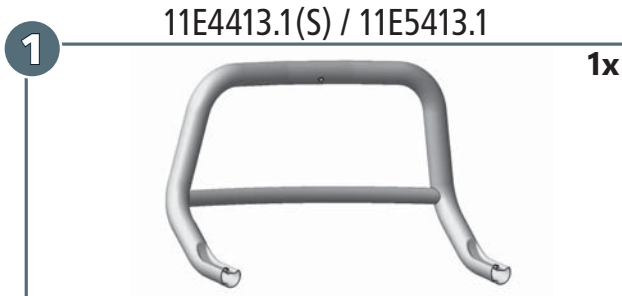

	M6x25; DIN 933 Zn	2x
	M6x40; DIN 933 Zn	1x
	M6x60; DIN 933 Zn	1x
	M8x25; DIN 933 A2	1x
	M12x1,25x30, 8.8; DIN 961 Zn	2x
	M8 x 20; DIN 912 A2	2x
	Ø3,5x13; DIN 7981B A2	2x
	M6; DIN 934 Zn	1x
	Ø4,2; DIN 9021 A2	2x
	Ø8,4; DIN 9021 A2	2x
	Ø8,4; DIN 9021 Zn	1x
	SW 13	1x

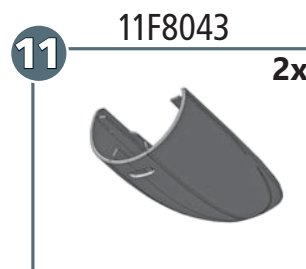
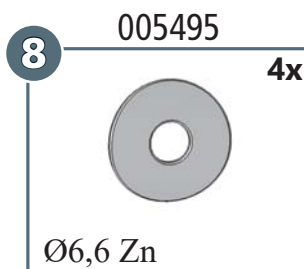
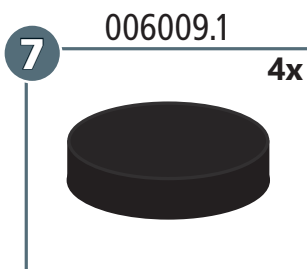
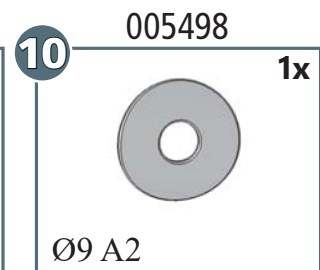
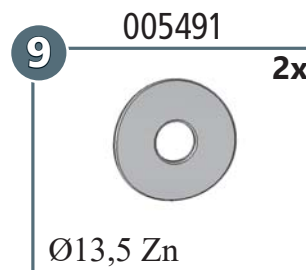
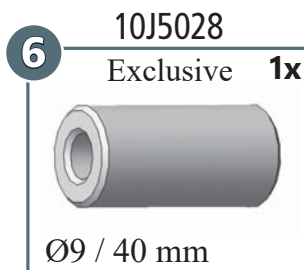
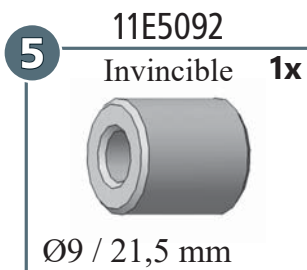
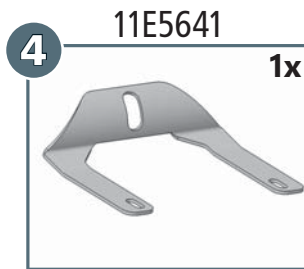
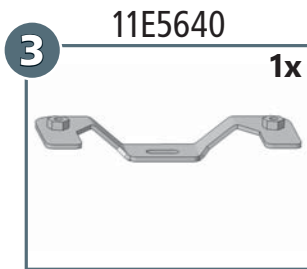

Artikel-Nr:

11E4413N (S) inox

11E5413N steel black

Revision 1: 09.09.2021



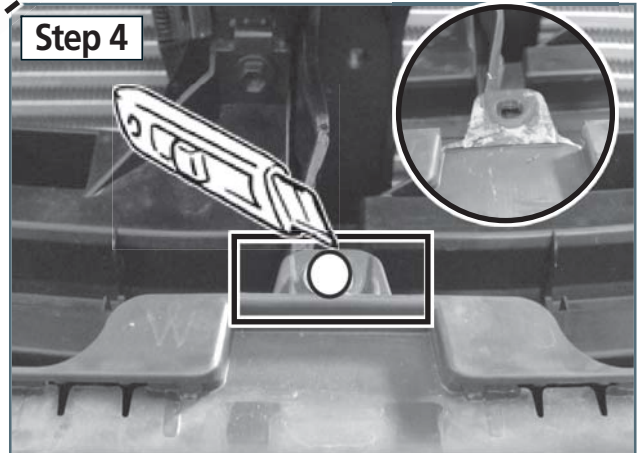
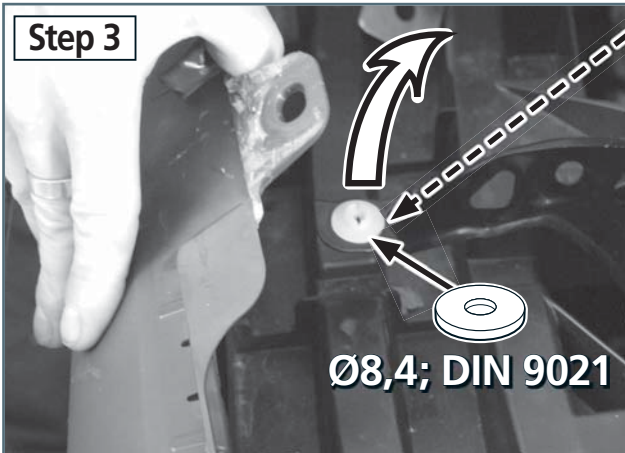
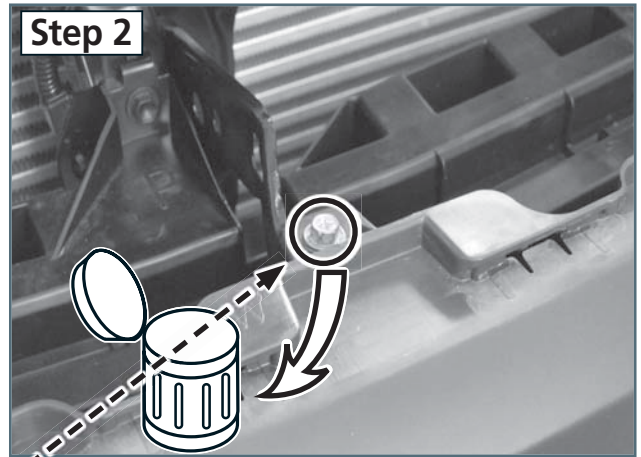
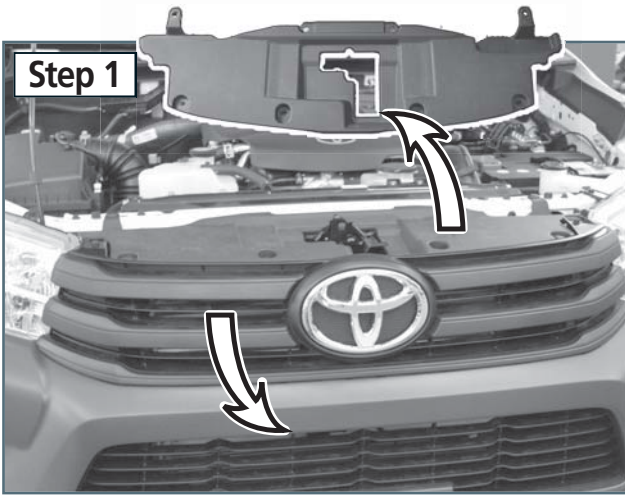

Invincible

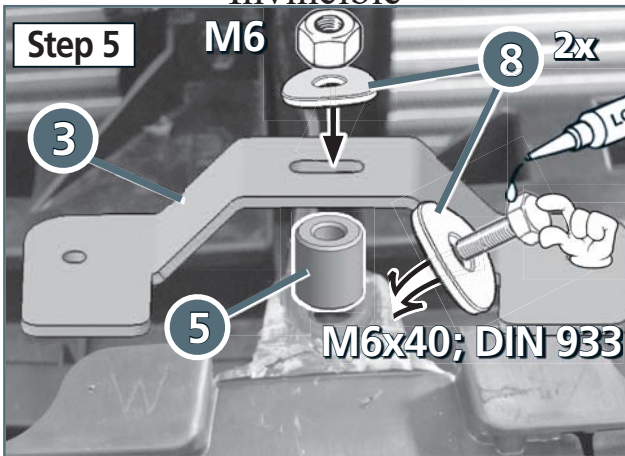

Exclusive

