

19D
4013

Skoda Kodiaq, Md. 03/2017

EU-Personenschutzbügel 60 mm mit Querrohr 42 mm
EU-Pedestrian Protection Bar 60 mm with cross pipe 42mm
Protection avant, homologuée CEE, 60 mm, traverse 42mm



*Compatible with Automatic Cruise Control /Forward Collision Mitigation
Kompatibel mit Abstandsregeltempomat /Auffahrvermeidungs-oder warnsystem
compatible avec radar de régulation de distance/ freinage autonome d'urgence



ASSEMBLY INSTRUCTION

Montageanleitung • Instructions de montage

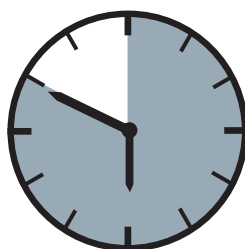

50 Minuten

article no.:
19D4013 (S) inox
19D5013 black steel

Revision 4: 25.08.2020



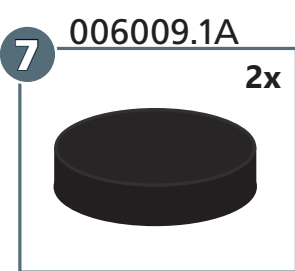
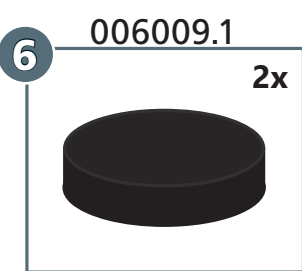
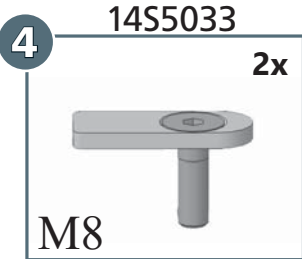
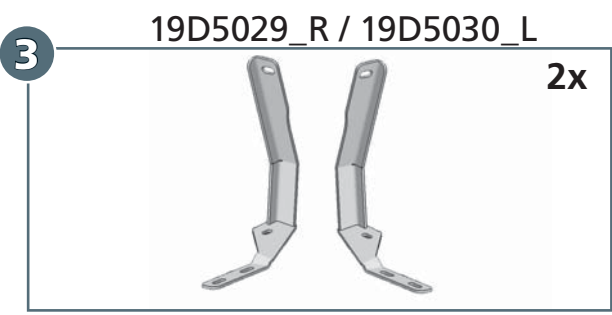
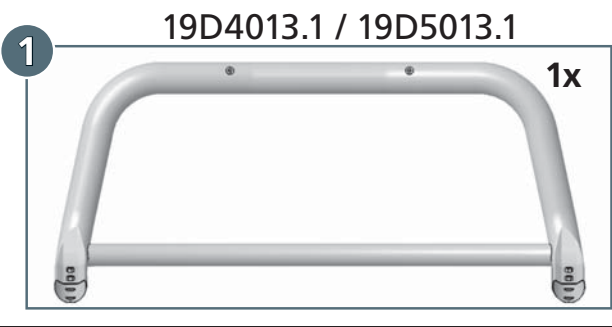
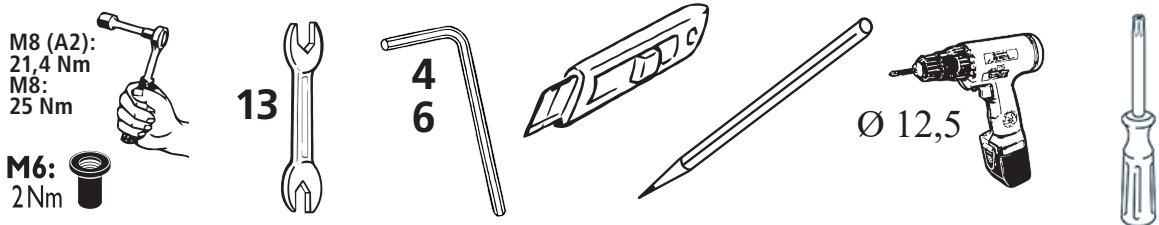

mounting kit: 19D9013

	M6x25; DIN 7991 Zn	4x
	M8x25; DIN 912 A2	4x
	M8x25; DIN 933 A2	2x
	Ø 3,5x13 (DIN ähnl.7981 B) A2	2x
	M6; DIN 439 A2	2x
	M8; DIN 934 Zn	2x
	Ø 8; DIN 127 A2	6x
	Ø 8; DIN 127 Zn	2x
	Ø 4,2; DIN 9021 A2	2x
	Ø 8,4; DIN 125 A2	4x
	Ø 8,4; DIN 9021 A2	2x
	Ø 8,4; DIN 9021 Zn	2x
	Getowell M6	4x
	GP-DZ-015x010-M6x50 NR55-V2A	2x
	SW 13	2x



article no.:
19D4013 (S) inox
19D5013 black steel

Revision 4: 25.08.2020



