

18N 4513

Mercedes X-Klasse, Md. 2016

EU-Pedestrian Protection Bar 76mm

EU-Personenschutzbügel 76 mm

Protection avant, homologuée CEE, 76 mm



*Compatible with Automatic Cruise Control /Forward Collision Mitigation
Kompatibel mit Abstandsregeltempomat /Auffahrvermeidungs-oder warnsystem
compatible avec radar de régulation de distance/ freinage autonome d'urgence



ASSEMBLY INSTRUCTION

Montageanleitung • Instructions de montage

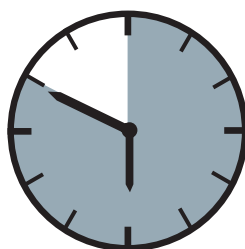

50 Minuten

article no.:

18N4513 (S) inox

18N5513 black steel

Revision 6: 01.06.2022





M6:
10 Nm
M8 (A2):
21,4 Nm
M8:
25Nm
M10:
50 Nm
M12:
87 Nm

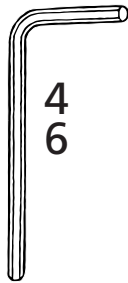
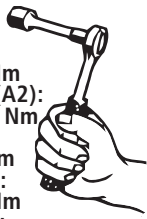

mounting kit: 18N9413

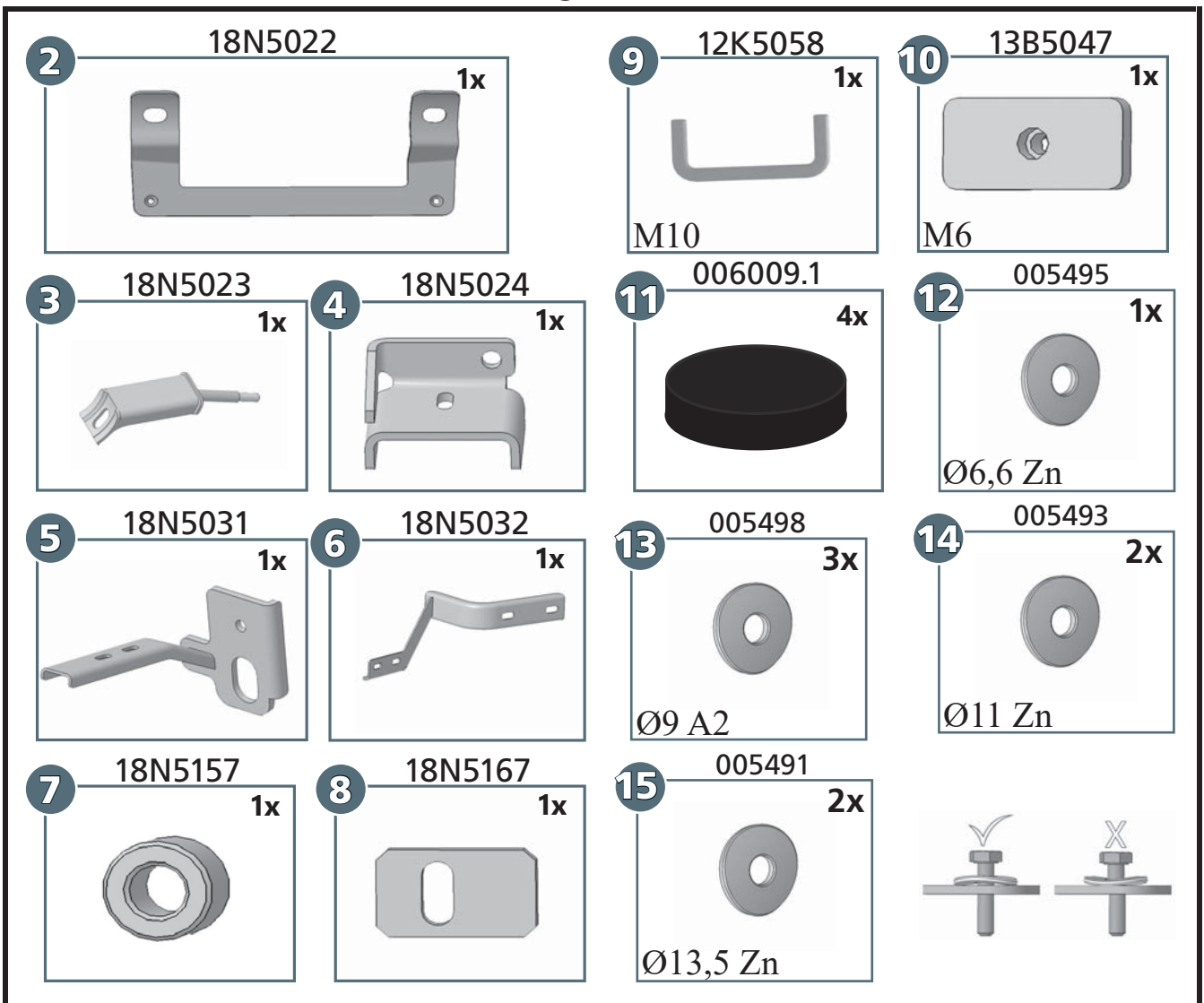







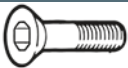
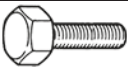

article no.:
18N4513 (S) inox
18N5513 black steel

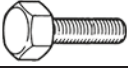
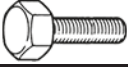
Revision 6: 01.06.2022



mounting kit: 18N9413

	M6x20; DIN 7991 Zn	2x
	M6x20; DIN 933 Zn	1x
	M8x25; DIN 912 A2	4x
	M8x25; DIN 933 A2	3x
	M12x60; DIN 933 Zn	1x
	M8; DIN 934 Zn	1x
	M10; DIN 934 Zn	2x
	M12; DIN 934 Zn	1x
	Ø 8,4; DIN 125 A2	4x
	Ø 8,4; DIN 125 Zn	1x
	SW 13	3x



NOT INCLUDED!
mounting kit: 18N9913

<p>5</p> <p>18N5076_R</p> <p style="text-align: right;">1x</p> 	<p>6</p> <p>18N5077_L</p> <p style="text-align: right;">1x</p> 
--	---

only for RHD
nur für Rechtslenker
seulement pour RHD

article no.:
18N4513 (S) inox
18N5513 black steel

Revision 6: 01.06.2022



