

**17W**  
**4317**

## Mitsubishi L200, Modell 2020

EU-Spoilerschutzrohr 51 mm gekröpft  
EU-Spoiler protective tube 51 mm cranked  
Tube de protection du spoiler vinklad CE 51 mm

**Das Produkt ist nicht mit Front-Kit pro (Sportstoßstange) montierbar!**  
**The product cannot be mounted with Front-Kit pro (sports bumper)!**  
**Le produit ne peut pas être monté avec Front-Kit pro (pare-chocs sport)!**

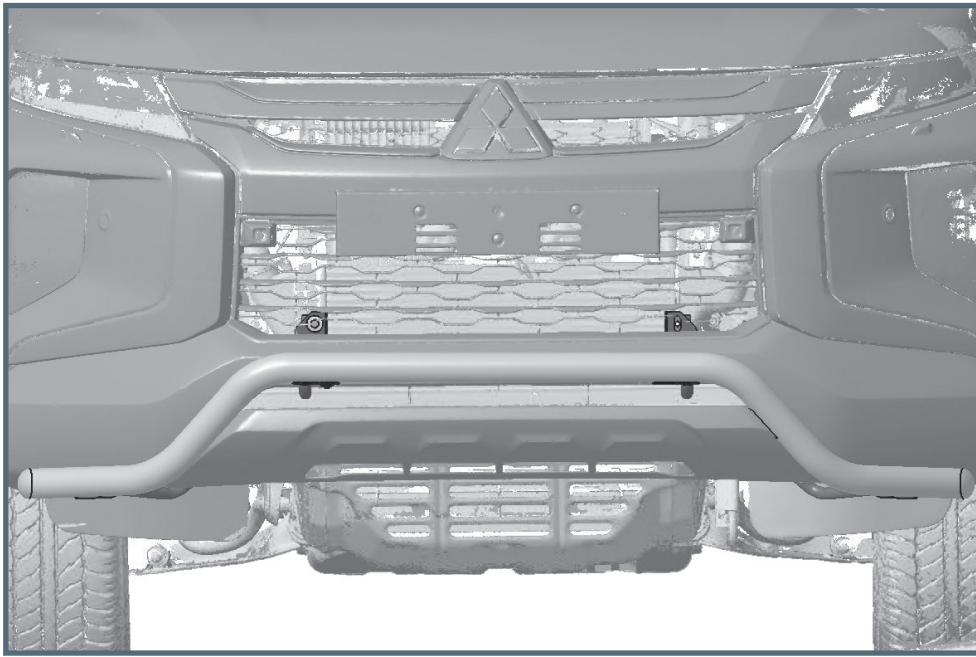

# ASSEMBLY INSTRUCTION

Montageanleitung • Instructions de montage

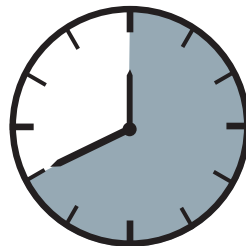

**40 Minuten**

article no.:  
17W4317 (S) inox  
17W5317 black steel

Revision 2: 08.11.2023

  
www.antec-online.de

M8 (A2):  
21,4 Nm  
M8:  
25 Nm  
M10:  
50 Nm



13  
17

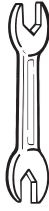

mounting kit: 17W9317

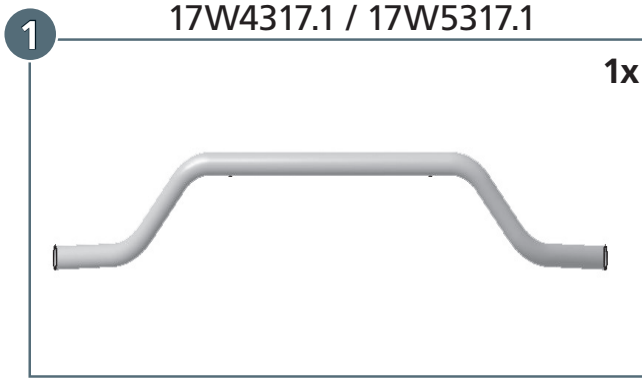

	M8x25; DIN 933 A2	4x
	M8x25; DIN 933 Zn	2x
	M10x100; DIN 933 Zn	2x
	M10x1,25-30; DIN 961 Zn	2x
	M10; DIN 934 Zn	2x

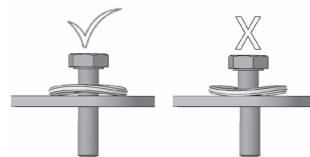
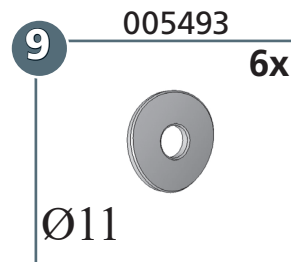
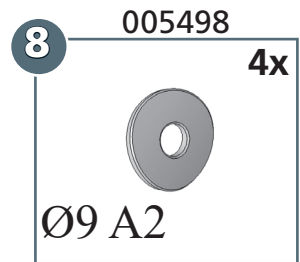
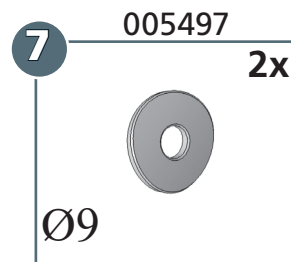
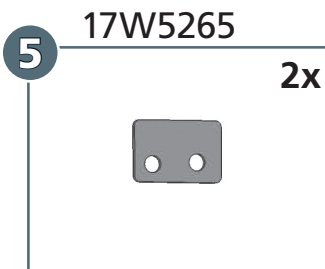
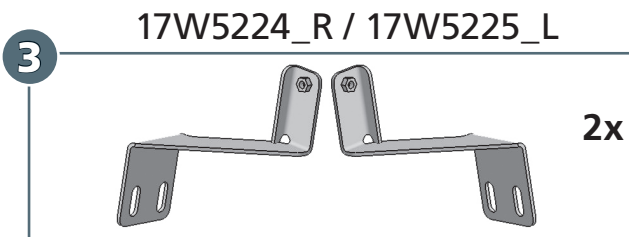
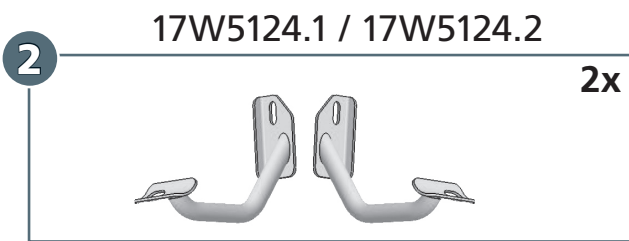

article no.:  
17W4317 (S) inox  
17W5317 black steel

Revision 2: 08.11.2023



