

**15V**  
**9213RNC**

## Ford Ranger Raptor; Md. 2023

EU-Pedestrian Protection Bar 76 mm with cross pipe 51 mm

EU-Personenschutzbügel 76 mm mit Querrohr 51 mm

Protection avant, homologuée CEE, 76 mm, traverse 51 mm

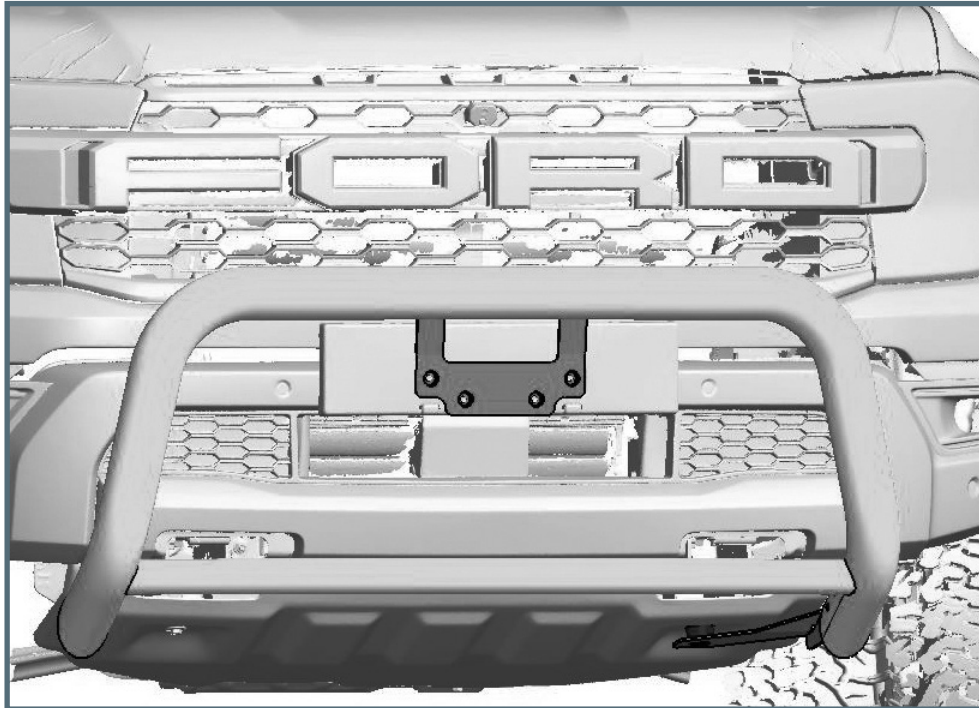

# ASSEMBLY INSTRUCTION

Montageanleitung • Instructions de montage

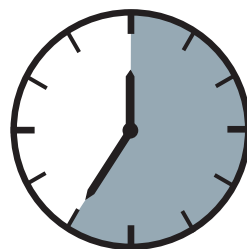

35 Minuten

article no.:  
15V9213RNC

Revision 1: 29.02.2024

  
www.antec-online.de

M6:  
10 Nm  
M8 (A2):  
21,4 Nm  
M10:  
50 Nm

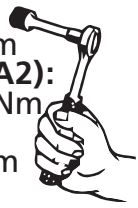

15V4213.1C(S) / 15V4313.1C(S)

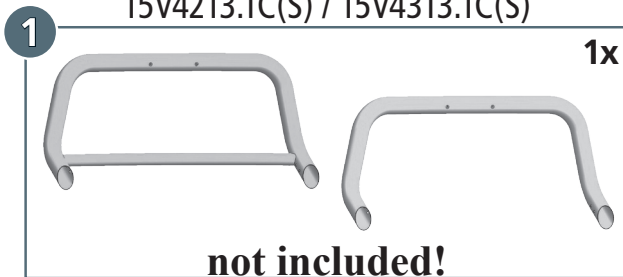

15V5544\_R / 15V5545\_L

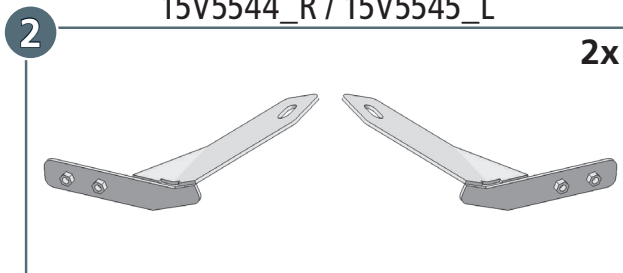

15V5535

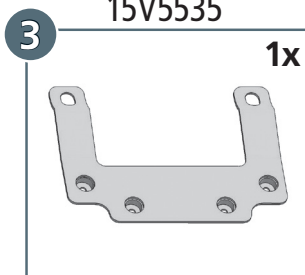

1355059

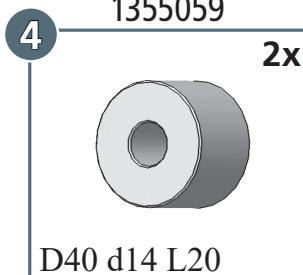

D40 d14 L20

005497

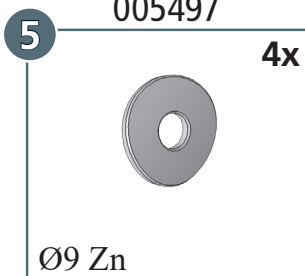

Ø9 Zn

005498

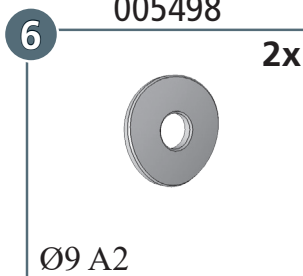

Ø9 A2

005493

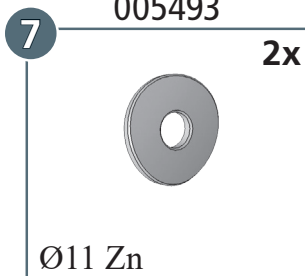

Ø11 Zn

006009.1

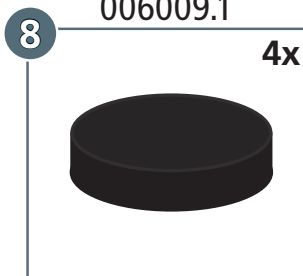

	M8x25; DIN 933 A2	2x
	M10x45; DIN 933 Zn	2x
	M6x20; DIN 933 Zn	4x
	M8x25; ähnl. ISO 7380 Zn	4x
	Ø4,8x19; DIN 7981C A2	4x
	Ø5,3; DIN 9021 A2	4x
	Ø6,4; DIN 9021 Zn	4x
	SW 13	2x

