

15V
4313NC

Ford Ranger; Md. 2023

EU-Pedestrian Protection Bar 76 mm

EU-Personenschutzbügel 76 mm

Protection avant, homologuée CEE, 76 mm

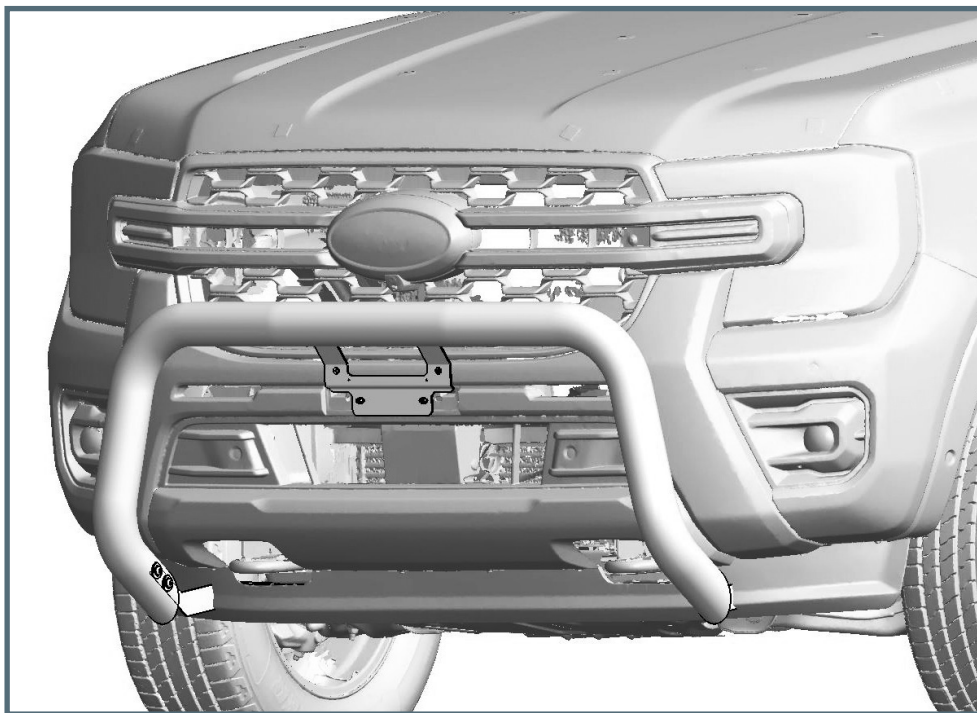

ASSEMBLY INSTRUCTION

Montageanleitung • Instructions de montage

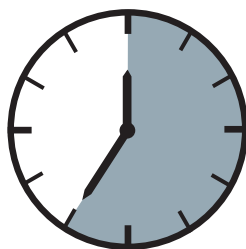

35 Minuten

article no.:

15V4313NC (S) inox

15V5313NC black steel

Revision 2: 05.02.2024



M6(A2):
8,8 Nm
M8 (A2):
21,4 Nm
M8 (Zn):
25 Nm

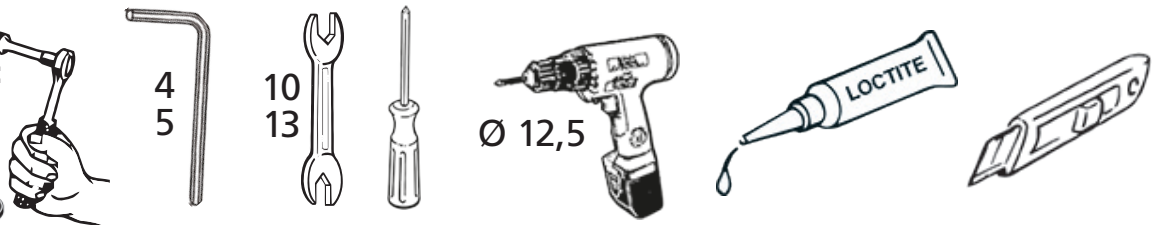

M6:
2 Nm

15V4313.1C(S) / 15V5313.1C



mounting kit: 15V9313NC

22K5046C_R / 22K5047C_L

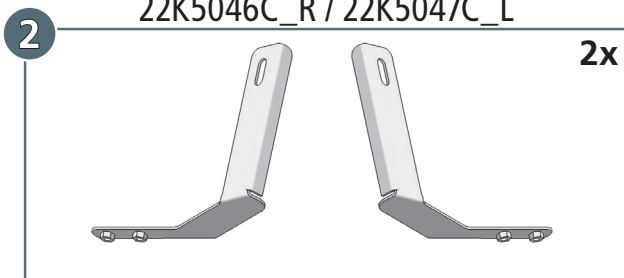

22K5048

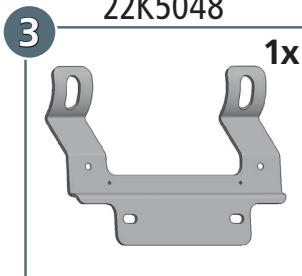

22K5022

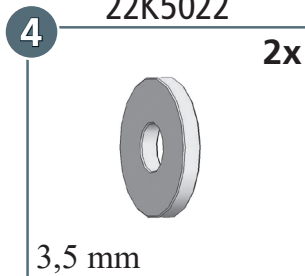

005498

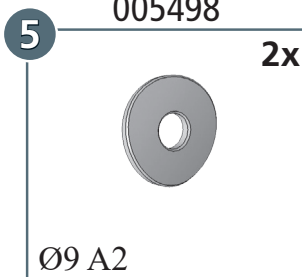



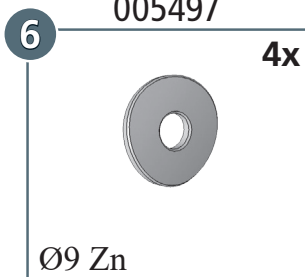

005497

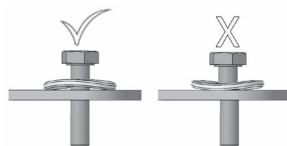
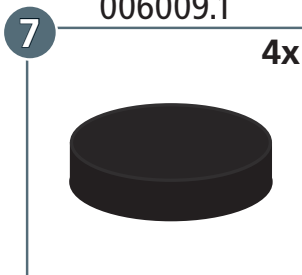

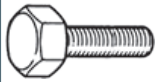
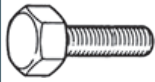
006009.1



	M8x30; DIN 933 A2	2x
	M6x25; DIN 933 A2	2x
	M6x25; DIN 7991 A2	2x
	M8x20; ähnl. ISO 7380 Zn	4x
	Ø6,4; DIN 9021 A2	2x
	GETO-WELL M6	4x
	SW 13	2x
	Ø4,8x19; DIN 7981C A2	2x
	Ø5,3; DIN 9021 A2	2x

article no.:

15V4313NC (S) inox

15V5313NC black steel

Revision 2: 05.02.2024



