

13L
4713

Ford Kuga, Modell 10/2016

Trend & Vignale

EU-Personenschutzbügel 60 mm mit Querrohr 42 mm

EU-Pedestrian Protection Bar 60 mm with cross pipe 42mm

Protection avant, homologuée CEE, 60 mm, traverse 42mm

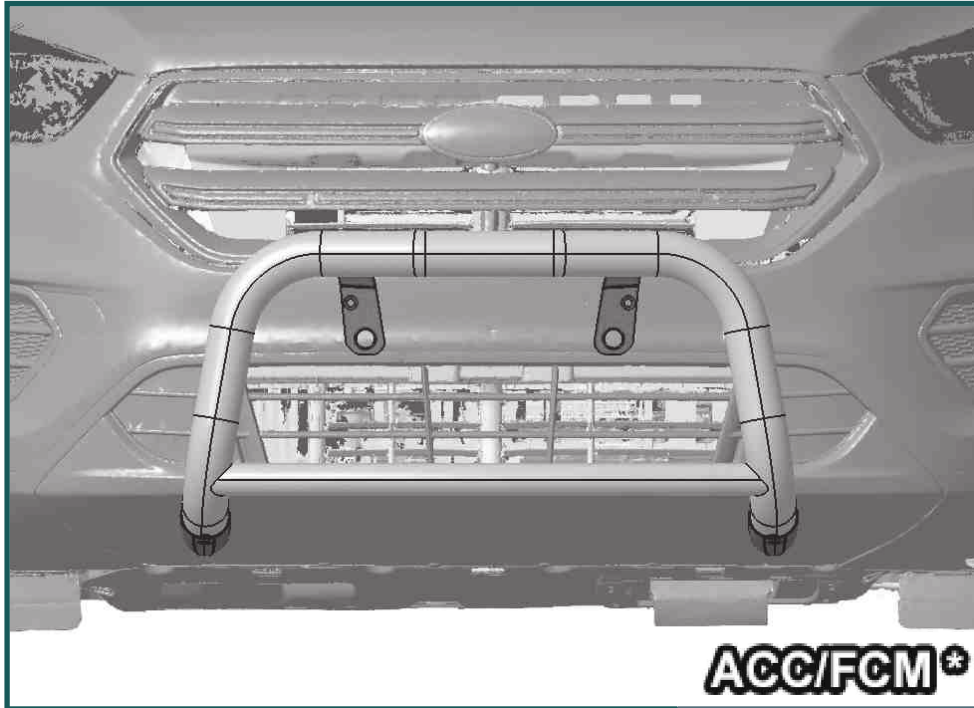

*Compatible with Automatic Cruise Control /Forward Collision Mitigation
Kompatibel mit Abstandsregeltempomat /Auffahrvermeidungs-oder warnsystem
compatible avec radar de régulation de distance/ freinage autonome d'urgence

ASSEMBLY INSTRUCTION

Montageanleitung • Instructions de montage

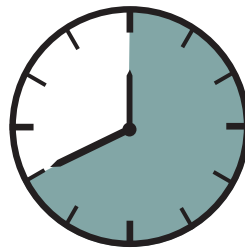

40 Minuten

Artikel-Nr:
13L4713 Stainless Steel
13L5713 Steel black

Revision 4: 17.07.2018



M8(A2): 21,4Nm
M6: 10Nm
M6: 2Nm

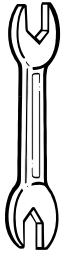

10
13

6

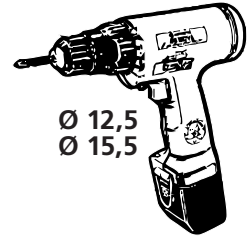
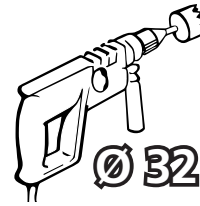
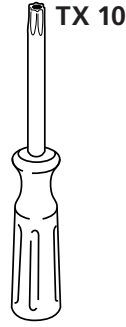
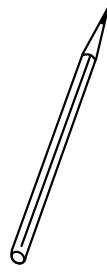

Ø 12,5
Ø 15,5

Ø 32

13L4713.1 / 13L5713.1

mounting kit: 13L9713

1

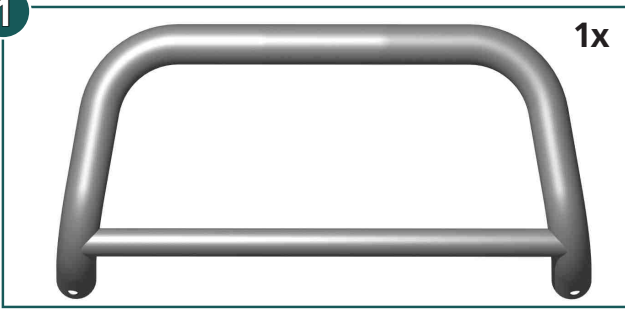

1x

2a

13L5042_R / 13L5043_L

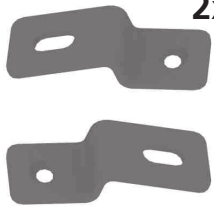

2x

2b

13L5046_R / 13L5047_L

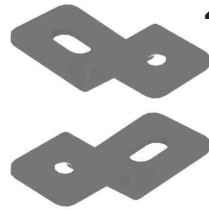

2x

Modell Vignale

3

13L5048_R / 13L5049_L

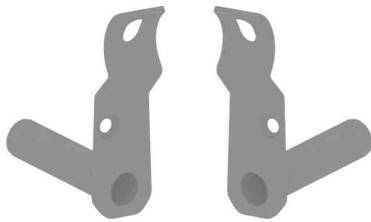

2x

4

11F8043



2x

5

006009.1



4x

	M6 x 25; DIN 7991 Zn	2x
	M6 x 25; DIN 933 Zn	2x
	M8 x 20; DIN 933 A2	2x
	M8 x 25; DIN 7991 Zn	2x
	M8 x 20; DIN 912 A2	2x
	Ø 4,8 x 19; DIN 7981 Form C A2	4x
	Ø 3,5 x 13; ähnl. 7981B A2	2x
	Ø 6,4; DIN 9021 Zn	2x
	Ø 8,4; DIN 9021 A2	4x
	Ø 5,3; DIN 9021 A2	4x
	Ø 4,2; DIN 9021 A2	2x
	Ø 6; DIN 127 Zn	2x
	Ø 8; DIN 127 A2	4x
	Getowell M6	2x
	Getowell M8	2x
	SW 13	2x



